

# Glassware Drying Ovens

## *User Manual & Setup Guide*

---

**TGD RANGE**

*Omron E5CC*

Thermoline Scientific Equipment Pty. Ltd.  
ABN 80 000 859 129  
10-12 Ross Place  
Wetherill Park, NSW 2164. Australia.  
Phone: +61 2 9604 3911  
email: [hello@thermoline.com.au](mailto:hello@thermoline.com.au)  
[www.thermoline.com.au](http://www.thermoline.com.au)

---

# Contents

---

<b>General Information</b>	<b>4</b>
<b>Product Specifications</b>	<b>5</b>
<b>Operating Environment</b>	<b>8</b>
Glassware Drying Oven Operating Environment	8
Bench Top Location	8
Electrical Connections	9
<b>Setup</b>	<b>11</b>
Unpacking	11
Moving	11
Castors	12
Glassware Drying Oven Location	13
Shelves	14
Inlet and Exhaust	15
Cleaning	16
Door Gasket	16
Port Hole	17
<b>Start Up Procedure</b>	<b>18</b>
Loading	19
<b>Omron User Guide</b>	<b>20</b>
Display Symbols	20
Temperature Control	21
Sensor Calibration	21
BMS Output	22
Manual Reset Safety Thermostat	23
<b>Troubleshooting</b>	<b>24</b>
Technical and Repair Support	25
<b>Warranty</b>	<b>26</b>



**General  
Warning Sign**

**Warning sign:** signifies a general warning, and indicates a risk to people specified by the supplementary sign that if not avoided, may result in death or serious injury.



**Flammable**

**Warning; Flammable:** signifies a flammable warning, and indicates a risk of flammable content as specified by the supplementary sign that if not avoided, may result in a fire by igniting flammable material.



**Warning;  
Electricity**

**Warning; Electricity:** signifies a electricity warning, and indicates a risk of contact with electricity as specified by the supplementary sign that if not avoided, could result in injury.



**Warning; Hot  
Surface**

**Warning; Hot Surface:** signifies hot surface warning, and indicates a risk to people specified by the supplementary sign that if not avoided, will result in contact with hot surface.



**General  
Prohibition Sign**

**General Prohibition:** signifies a prohibited action, indicates a risk to people specified by the supplementary sign that if not avoided, will result in death or serious injury.



**Do Not Expose  
Outside**

**Do Not Expose Outside:** signifies prohibiting the exposure to direct sunlight, and indicates a raised temperature due to sunlight or placement on hot surface can cause harmful damage to cabinet.

---

# General Information

Glassware Drying Oven User Manual  
By Thermoline Scientific

---

This user manual is intended for Thermoline's glassware drying oven range. We recommend that you read this user manual the whole way through before you start using the cabinet. Consider this manual as a part of the cabinet and an integral part to its function. We recommend keeping it close and within easy access.

---

The Thermoline glassware drying ovens 80F, 150F, and 250F models are designed and manufactured to dry glassware.

The Thermoline range of ovens are set to function with specific operating ranges. The optimum operating conditions will be explained further in this manual.

- Operating Temperature of Ambient +10°C to 80°C



# Product Specifications

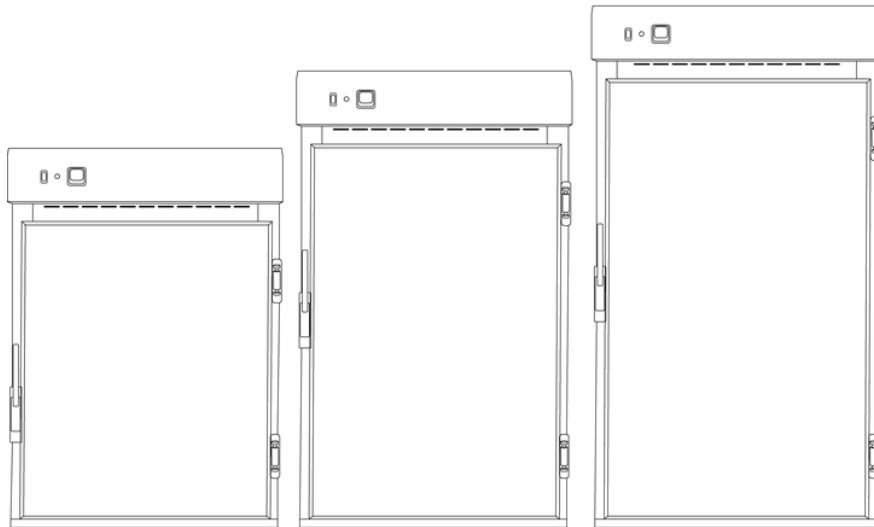

## Dimensions

### External

	TGD-80F	TGD-150F	TGD-250F
WxDxH (mm)	520x550x800	630x650x1010	630x650x1360

Note: Inlet and Exhaust ports extend the overall height of the ovens by approximately 40mm.

### Internal

WxDxH (mm)	390x400x400	500x510x600	500x510x950
------------	-------------	-------------	-------------

### Clearance

	TGD-80F	TGD-150F	TGD-250F
Front (mm)	520	630	
Back (mm)	100		
Sides (mm)	100		

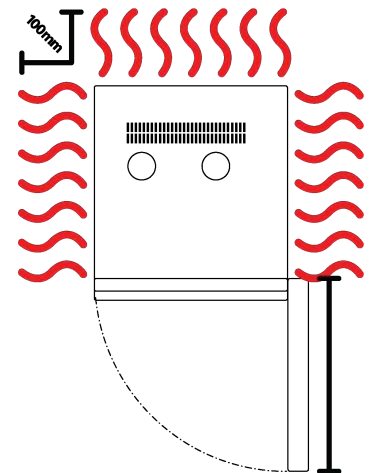

## Technical Specifications

### Technical Specification

	TGD-80F	TGD-150F	TGD-250F
Temperature Range	Ambient +10°C to 80°C		
Temperature Control Stability	+/- 0.1°C		
Temperature Uniformity	+/-1°C @ 80°C		
Heater Power	1400 watts	2000 watts	
Electrical	6A/230V	9A/230V	
Nominal Capacity	80L	150L	250L
Porthole Diameter	13mm		
Weight	80kg	120kg	130kg

### Features

Shelves (max @100mm spacing)	2 (max 3)	3 (max 4)	4 (max 6)
Lockable Castors	Optional	✓	✓
Internal Fan	✓	✓	✓
Omron E5CC	✓	✓	✓
Glass Door	✓	✓	✓
Fibreglass Insulation	✓	✓	✓

### Safety

Over Temperature Safety	✓	✓	✓
Over Current Protection	✓	✓	✓

### Options

BMS Plug	No volt contact closure plug and socket connection to a Building Management System
Additional Shelves	Additional Stainless Steel shelves to suit
Door Locks	Key lockable door locks
Customisable Port Hole	Add additional stainless steel 13mm port holes or choose 50mm port holes
General Drying	See TD-range for oven models specific to drying to +200°C
Natural Convection	See TO-range for oven models without fan forced circulation

## Glassware Drying Oven Operating Environment

Ensure that the drying oven is placed in the correct environment, away from direct sunlight or direct heat sources such as heaters (Fig 1). The product shouldn't be placed in a room where the ambient temperature exceeds that of which it was designed to operate.

Drying ovens should be stored inside at all times. Failure to adhere to this could cause significant drops in cabinet performance and damage to items stored inside.

### Extreme Operating Environment:

- **Temperature:** 10°C to 32°C (+/-2.0°C)
- **Humidity:** Up to 85%RH

### Optimal Environment: (Fig 2)

- **Temperature:** 23°C (+/-2.0°C)
- **Humidity:** 50%RH (+/-5%RH)

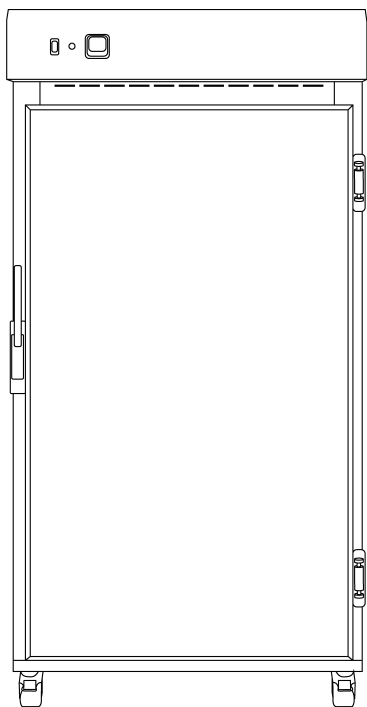

Fig 1. Suitable Environment

## Bench Top Location

### Bench Top Requirements:

- Under no circumstances should any ovens be stacked on top of each other (Fig 2).
- Thermoline 150 litre ovens have removable castors for benchtop storage. To safely remove castors, simply tip the cabinet over gently onto its back or side and unscrew the castors from the bottom of the cabinet (Fig 3). This is a two person job so please get assistance.

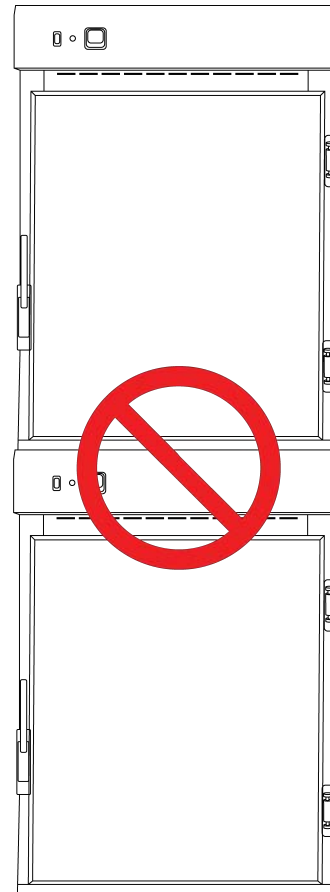

Fig 2.



Fig 3.

# Operating Environment

## Electrical Connections

Glassware drying ovens require a 10amp 230V 50hz power supply.

A dedicated outlet should be used for all ovens. Do not use power boards or the like. A 3-pin moulded plug is supplied as standard.

### Electrical requirements

TGD-80F  
TGD-150F  
TGD-250F

10A/230V

### Electrical Conditions:

- All glassware drying ovens include a 2.5m removable mains power lead with a three-pin plug and right angle female IEC plug. Ensure the product is reasonably distanced from the power supply. (**Fig 1**)
- On the oven itself is a male IEC socket (**Fig 2**) and (**Fig 3**).

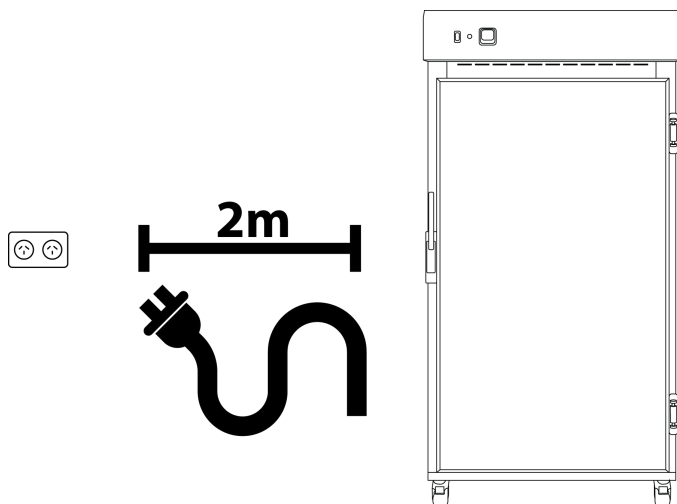

Fig 1. Suitable distance from power supply (2m)



Fig 2. 10amp IEC socket

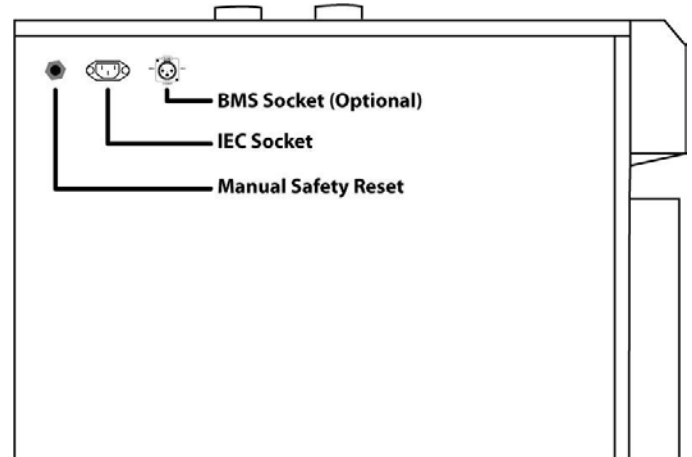

Fig 3. Location of of the IEC socket.



## Operating Environment Warnings

---



Do not store items on top of the cabinet as this will also affect ventilation! CAUTION: When installing more than one cabinet in the same location ensure that they are positioned in such a way that warm air exhausted from one cabinet, is not drawn directly into the other cabinet.

Glassware drying ovens should be stored inside at all times. Failure to adhere to this could cause significant drops in cabinet performance and damage to items stored inside.

---



Glassware drying ovens are not suitable for use with flammable solvents! They are fitted with components that may be the source of ignition.

---



The glassware drying ovens are designed for large capacity drying, and hot moist air will be discharged.

## Unpacking

### Unpacking process for foam wrapped or boxed

- The glassware drying oven will be delivered foam wrapped and on its castors via sensitive freight (Fig 1) or in a box on a skid (Fig 2).
- If the glassware drying oven is delivered on a skid, a forklift may be required to lift it off the skid.
- Please don't dispose of the packaging until the oven is inspected. If damage is present upon opening your package, notify your supplier or Thermoline Scientific without delay on +61 2 9604 3911 or email at [service@thermoline.com.au](mailto:service@thermoline.com.au).



Fig 1. Unpacking Process (foam wrapped)

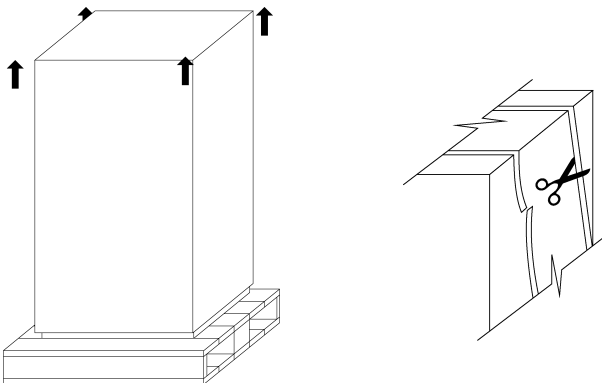

Fig 2. Unpacking Process (Box)

## Moving

### Moving the glassware drying oven:

- Ensure that the oven is rolled on an even and flat surface. Uneven surfaces can cause the oven to fall over.

**NOTE:** Glassware drying ovens are 'Top Heavy'. Do not move the cabinet too quickly. (Fig 3 & 4)

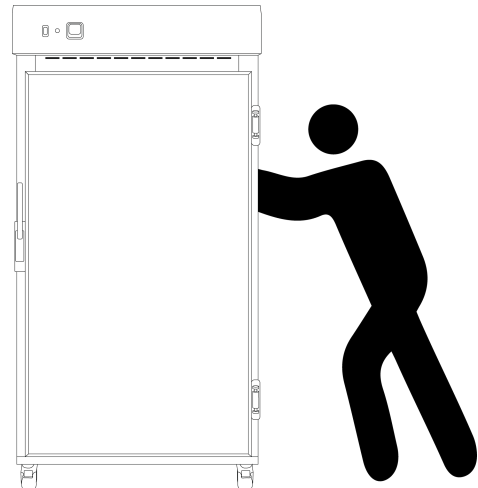

Fig 3. Safe moving of cabinet.

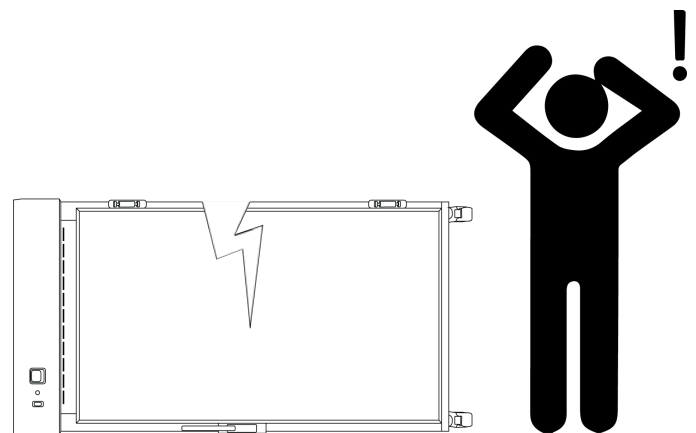
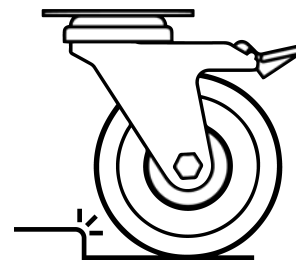

Fig 4.

## Setup

### Castors

The glassware drying ovens are equipped (or can be equipped) with lockable castors to prevent cabinet movement.

#### Castor Setup:

- Ensure that the glassware drying oven is placed on an even and flat surface. Uneven surfaces can cause issues within the cabinet. Uneven surfaces can cause the cabinet to fall over or roll away with unlocked castors.
- Castors can be fixed in place by pushing down on the brake lever. Ensure the castors are locked to prevent unwanted movement from the drying oven (**Fig 1**).
- Ensure when placing the glassware drying oven into place that the castors can be accessed so they can be locked (**Fig 3**) and unlocked (**Fig 2**). Please contact your supplier or Thermoline should there be any damage to the castors.

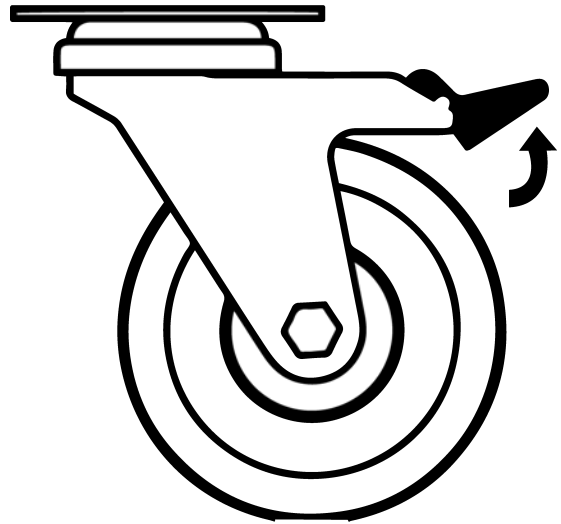

Fig 2. Castor Unlocked

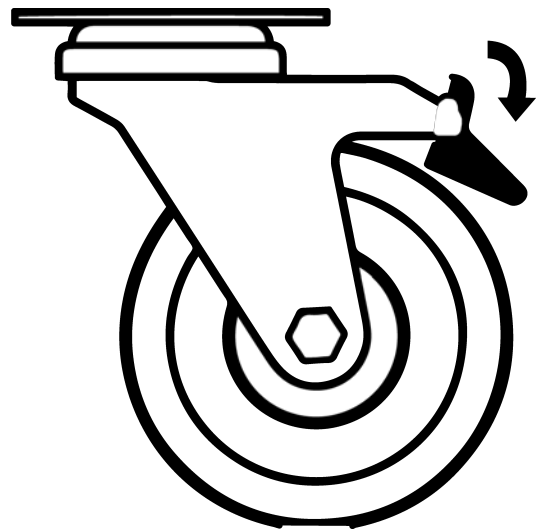

Fig 3. Castor Locked



Fig 1.

## Setup

### Glassware Drying Oven Location

#### Location Requirements:

- The glassware drying oven requires a level surface to operate correctly. (Fig 1)
- Do not store items on top of the glassware drying oven (Fig 2). Space is required to accommodate the inlet and outlet vents.
- The glassware drying oven requires ventilation. Thermoline still suggests 100mm on the sides and back that also aids with accessibility (Fig 3). 300mm at the top to ensure the inlet and outlet vent is not obstructed in any way.
- The glassware drying oven door should also be allowed to open and close at full range. (Fig 4)

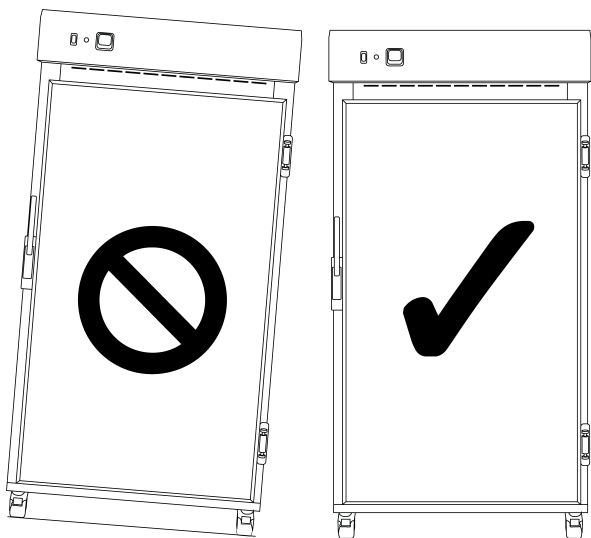

Fig 1. Correct Levelling

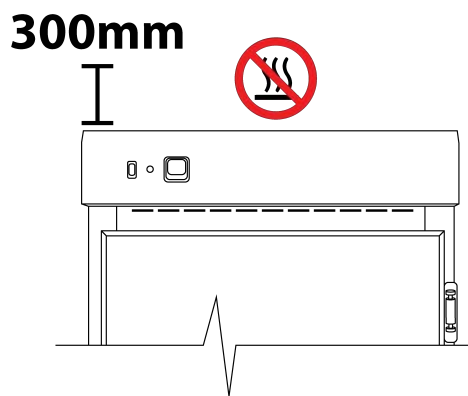

Fig 2.

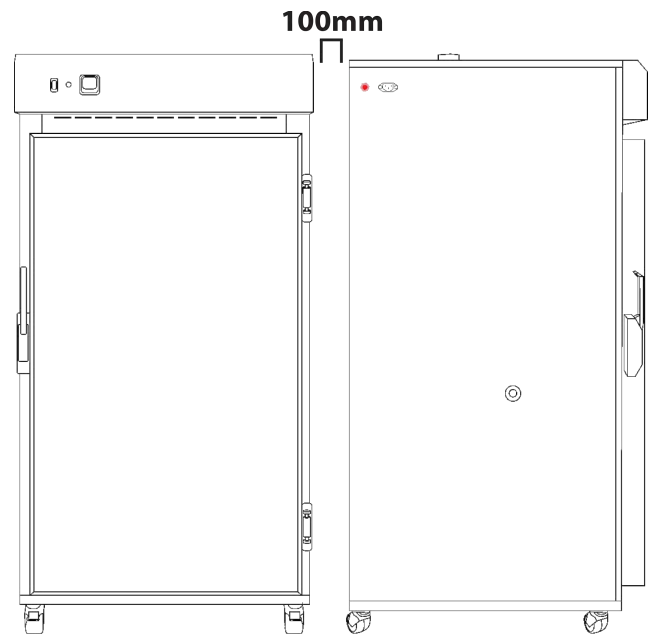

Fig 3.

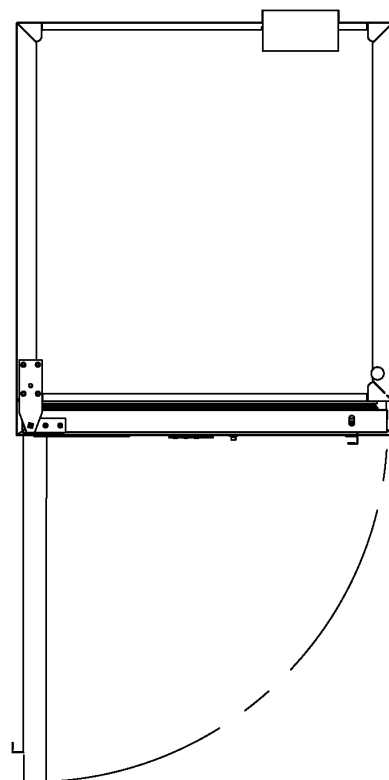

Fig 4.

## Setup

### Shelves

All ovens come equipped with shelves used for holding items while the oven is in operation. They allow for more than one item to be conditioned at a time. The shelves can be adjusted to different heights to accommodate different size items.

#### To adjust the shelf clips you must:

- Hook the top of the clip into the slot seen below.
- Pinch and squeeze the base of the clip
- Push base of clip into slot and release.
- To remove, repeat process.

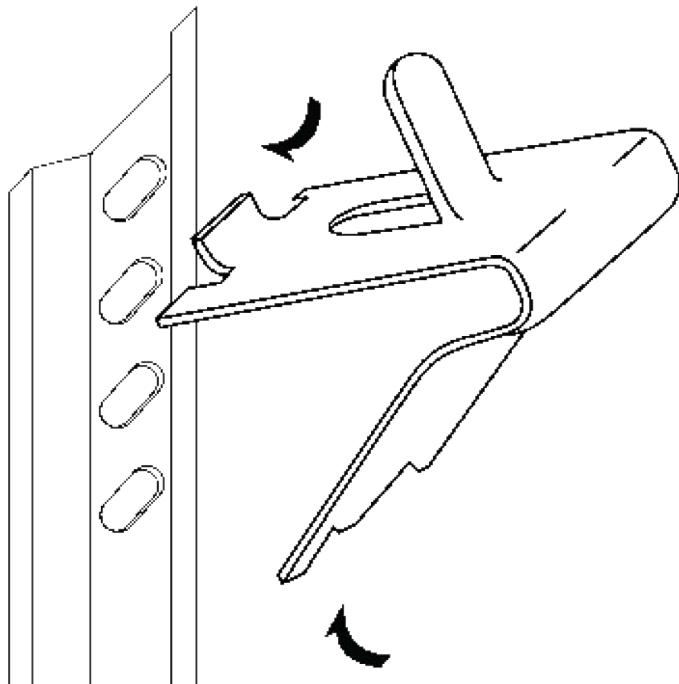

#### SAFETY NOTE:

- The edges of the clips can be sharp. Thermoline recommends using protective gloves while adjusting or moving the clips (e.g. leather gloves).



#### Shelving:

- All ovens are supplied with adjustable shelf clips to accommodate different size items within the cabinet, The amount of shelf clips supplied changes depending on the size of the cabinet ordered.

Model	Shelvex Length (mm)
TGD-80F	304
TGD-150F	455
TGD-250F	760

## Setup

### Inlet and Exhaust

All glassware drying ovens feature an inlet and an exhaust port on top of the cabinet. The inlet regulates the amount of fresh (dry air) that enters the cabinet and the outlet regulates the amount of exhaust air that can exit the cabinet. In combination, this regulates the rate of drying.

#### Exhaust Requirements:

- The top covers of the inlet and exhaust can be rotated either way to open up the exhaust and allow airflow (**Fig 2**). The air vents are located on the top of the cabinet. (**Fig 1**)
- On all glassware drying ovens covered in this manual the exhaust is on the left and the inlet is on the right as you look at the oven. Due to the location and number of fans in the different models the location may differ slightly, but they are still in this configuration. (**Fig 3**).
- The drying oven's vents can also be connected to a ventilation system whether it is exhaust only or both inlet and exhaust. To do so, you must first remove the vent covers (**Fig 4**).
- To prevent a potential pressure drop, please ensure that the pipe is no smaller than 75mm in diameter for proper ventilation (**Fig 4**).

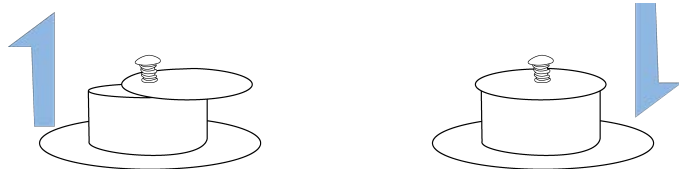

Fig 3.

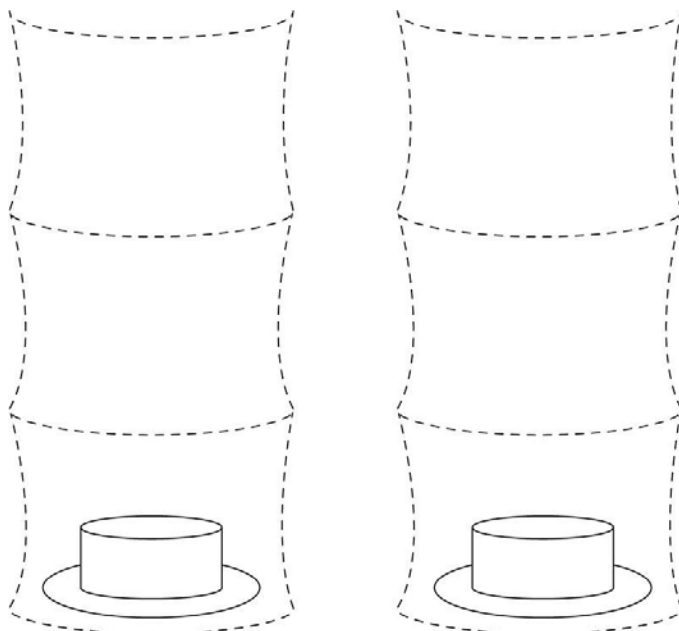

Fig 4. Recommended minimum diameter 75mm

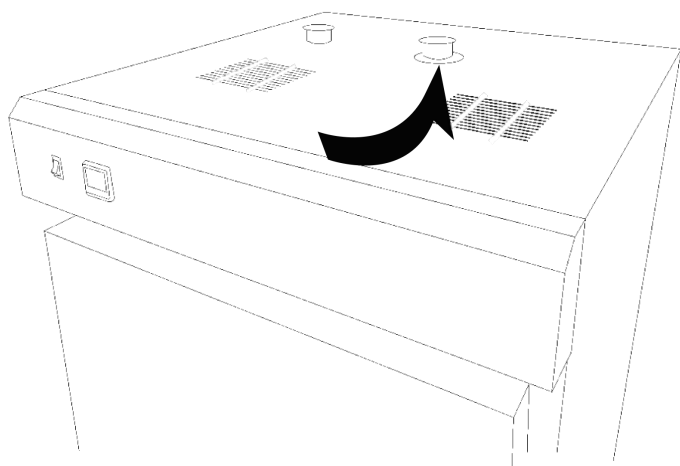

Fig 1.

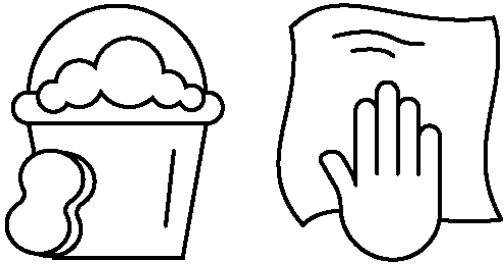

Fig 2.

## Setup

### Cleaning

The interior, exterior, and door gasket can be cleaned as often as required using a soft cloth and soapy water. Never use abrasive cleaners or scouring pads as these will scratch the surface and may result in corrosion. Never use caustic type cleaning agents.



All cabinets have electrical components. Power should be turned off prior to cleaning. These items should not be subjected to any levels of moisture.

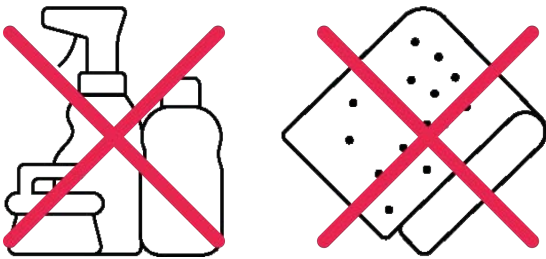

### Door Gasket

The door gasket should be cleaned regularly with a mild soap solution. If a gasket is to be replaced, please contact Thermoline Scientific. Regular inspection is recommended.

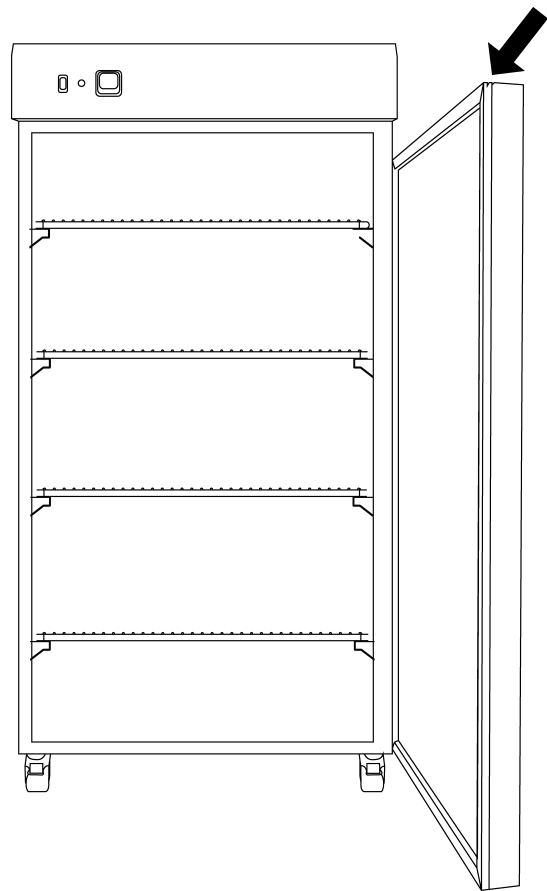

## Setup

---

### Port Hole

The port hole can be found on the left side of the glassware drying oven. The cabinet comes equipped with a plug that may be removed by simply pulling it out. Keep the plug safe in case the port hole needs to be closed again.

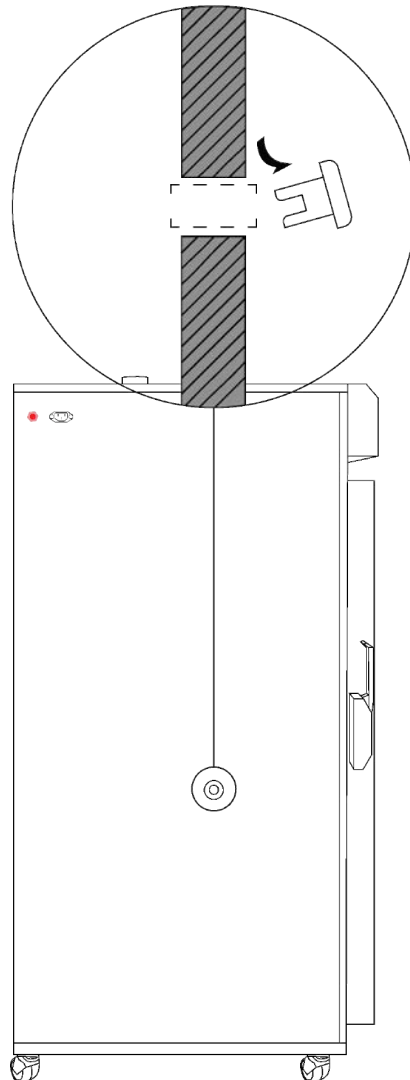

### Setup Warnings

---



Ensure when placing the cabinet into place that the castors can be accessed so they can be locked and unlocked. Any damage to the castors must be noted to the supplier or manufacturer

Ensure there are no blockages around or on top of the exhaust as this will effect proper ventilation.



Caution must be taken when removing the packaging particularly when using knives to cut tape and cardboard.



## Start Up Procedure

### Start Up process:

- Before proceeding, please make sure that all internal and external packaging has been removed from the appliance and that all tape, plastic bags and foam pieces have been removed.
- Take the supplied lead and plug it into the male IEC socket on the side of the oven. Next, plug the 3 pin plug into a 10amp General Purpose Outlet .
- Turn the main switch adjacent to the temperature control to 'ON' to start the Oven.
- The controller will go through a warm up period where all segments of the display will be on, before indicating the set temperature (SV) on the lower display and the oven actual temperature (PV) on the top display.

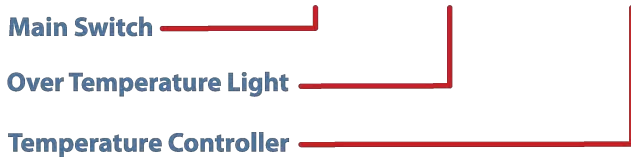
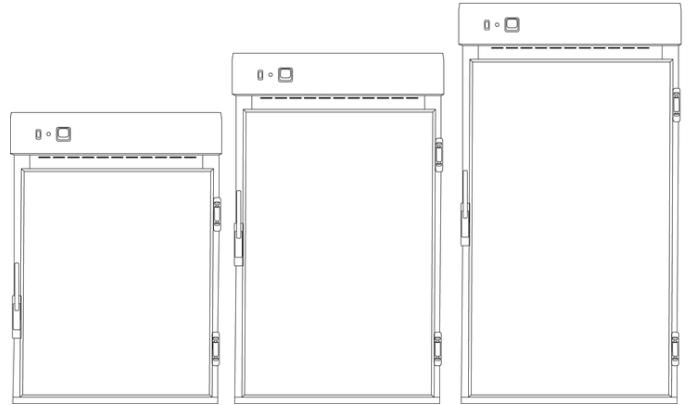

## Start Up Procedure

### Loading

Glassware drying ovens require constant air flow throughout the cabinet to maintain the desired temperature. Correct loading of the shelves must be considered for efficient cabinet performance.

#### Loading Requirements:

- Distribute the load evenly over all the shelves rather than stacking everything on one shelf. This is to ensure unobstructed airflow throughout the chamber.
- Ensure the highlighted area of the cabinet is clear of all obstructions to ensure that proper ventilation is allowed throughout the cabinet. (Fig 1 & 2.)
- Never block off air vents in the rear panel.
- Do not load samples on the floor of the drying oven.

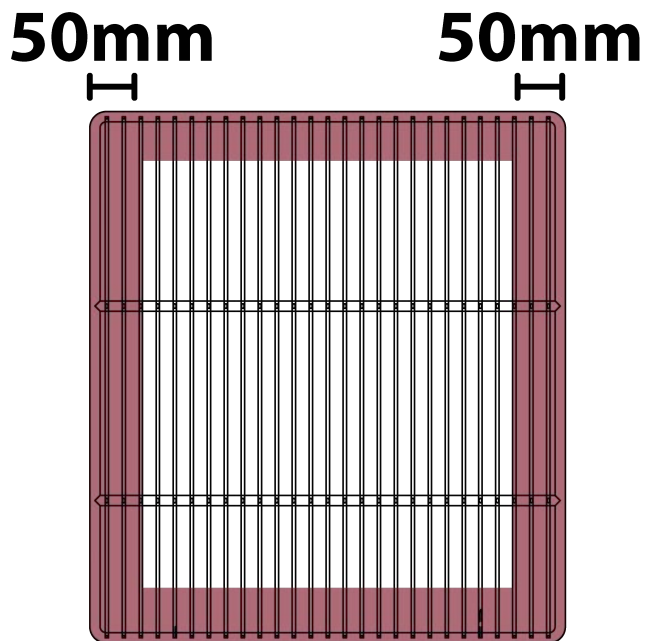

Fig 1.

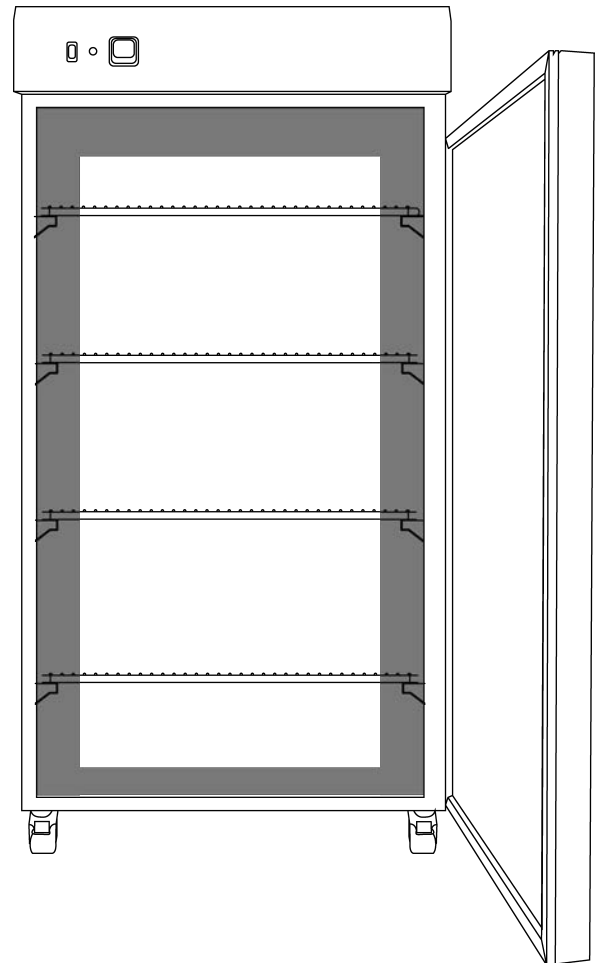

Fig 2.

The controller is an Omron E5CC microprocessor based instrument with digital indication of set temperature and operating temperature. The instrument has been factory configured for range, sensor type, and engineering parameters for optimum control.



**Note:** Limited access to the controller is available. The operator has access to alter the temperature set point and parameters used for calibration purposes only.



**Scroll Button:** Used to view the set temperature target and start/reset the ramp/dwell function.



**Page Button:** Used to view calibration offset parameter and the ramp/dwell control parameters.



**Increase/Decrease Button:** Used to increase and decrease the parameter settings.



**Side Arrow:** Used to move the cursor when changing temperature

**PV**

**Process Value:** Current temperature within the cabinet

**SV**

**Set Value:** Set temperature within the cabinet.

## Display Symbols

The Omron E5CC controller comes with an array of functions. The table below is an overview of the LED indicators displayed throughout use. Familiarise yourself with them so you are able to recognise problems or faults easily.

LED	Name	Meaning
SUB1	Auxillary Output 1	N/A
SUB2	Auxiliary Output 2	N/A
SUB3	Auxiliary Output 3	High Alarm
OUT1	Control Output 1	Heat Output ON
OUT2	Control Output 2	N/A
CMW	Communications Wiring	N/A
STOP	Stop	N/A
RSP	Remote SP	N/A
MANU	Manual	N/A
TUNE	AT/ST	N/A
	Setting Change Protection	N/A

A	b	C	d	E	F	G	H	i	J
A	B	C	D	E	F	G	H	I	J
K	L	M	N	o	P	Q	R	S	t
K	L	M	N	O	P	Q	R	S	T
K	U	W	X	Y	Z				
U	V	W	X	Y	Z				

## General Controls

### Temperature Control

#### How to

Use the “<<PF” button to move the cursor. The digits in **SV** will flash, indicating that it can be changed.

Change the temperature by using the “UP” or “DOWN” arrows. When the desired temperature is set, leave for a few seconds and the digits will stop flashing to confirm entry.



UP



DOWN



SCROLL



SIDE ARROW



PAGE



### Sensor Calibration

There are a number of factors that will affect the accuracy of the temperature displayed in relation to the actual temperature inside the Oven. These could include the following:

- Sample load inside the cabinet (the load should be distributed evenly).
- Product temperature (at higher temperatures the heat loss from the product will be greater).
- Location of the sensor (the temperature sensor can never be placed in the centre of the oven because it could be damaged).

The Omron temperature control has a parameter that can correct the temperature displayed. This sensor correction parameter is displayed as “INS” (Input Shift).

In simple terms, this parameter adds or subtracts a correction value to the displayed temperature to make it read the correct temperature.

The calibration sensor can be affixed to the centre of the middle shelf.

Once the oven has stabilised, any difference in the temperature reading can be offset using the sensor correction parameter.

The calibration parameter can be accessed as follows:

#### How to

Press **PAGE** to display sensor correction parameter.



Use the **UP** or **DOWN** button to adjust the sensor correction.

After this, allow the digit to stop flashing and the screen will display the adjusted value.

## General Controls

### BMS Output

The glassware drying oven can be fitted with an optional 3-pin socket to allow for connection to a building monitoring system or phone dialler. A plug is also supplied separately to connect the socket to your system.

The alarm contacts have no voltage present but we recommend that the wiring is connected by a suitably qualified technician.

**An alarm can be triggered by the following:**

- Loss of power
- High temperature inside cabinet (2°C above setpoint)

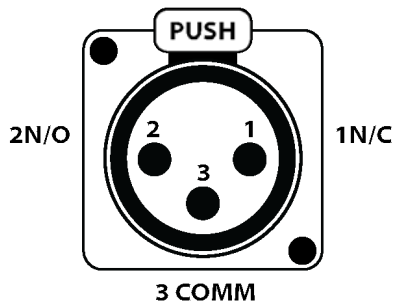

**1N/C:** Will open loop upon alarm situation. This is the optimal option as any break in the loop is detected.

**2N/O:** Will close loop upon alarm situation.

**3COMM:** At least one wire in connected to this pin.

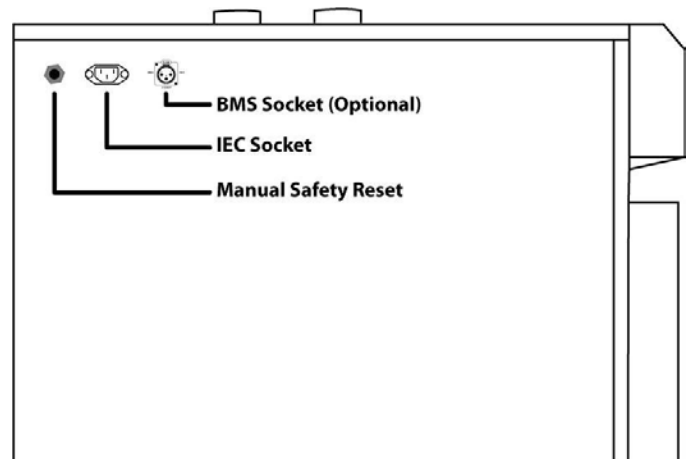

Location of BMS plug

## General Controls

### Manual Reset Safety Thermostat

The over-temperature safety thermostat is not operator adjustable. It will electrically isolate the heating elements in the event of an over-temperature situation. The main aim of this safety is to protect from overheating in the event that there is no airflow through the cabinet. This could be a failure of the air circulating fans or the cabinet being overstocked.

#### Resetting the over-temperature safety thermostat:

- Allow the cabinet to cool down before resetting the thermostat.
- Locate the safety reset at the back of the cabinet. It is displayed as a red or black knob. **(Fig 1)**
- Once the cabinet has cooled down, turn the black or red knob anti-clockwise. **(Fig 2)**
- Once the knob is off, press the red button firmly until you feel a “click”. This will restart the circulating fan and turn the digital display on again.

**NOTE:** This will allow the heaters to operate again. If this keeps tripping contact a qualified service technician to investigate possible causes of fault.

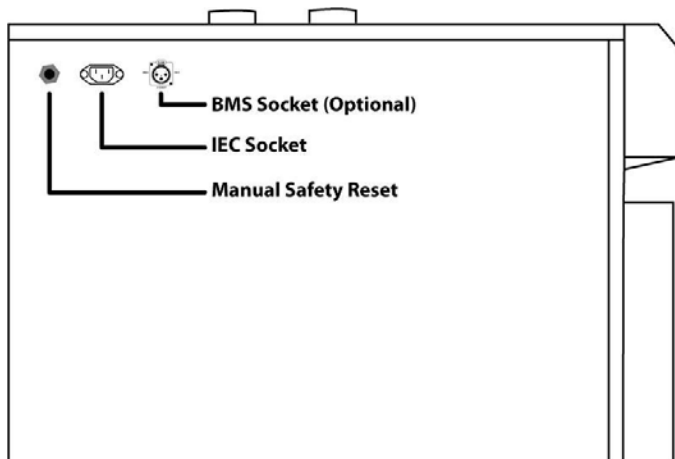

Fig 1.

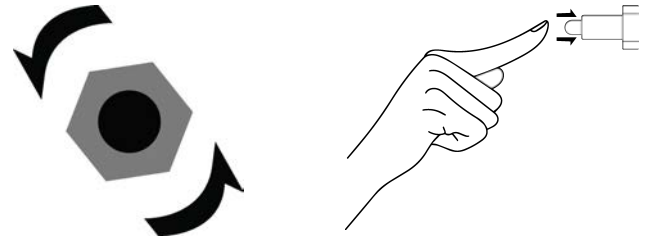

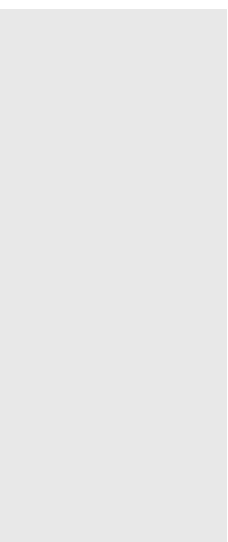
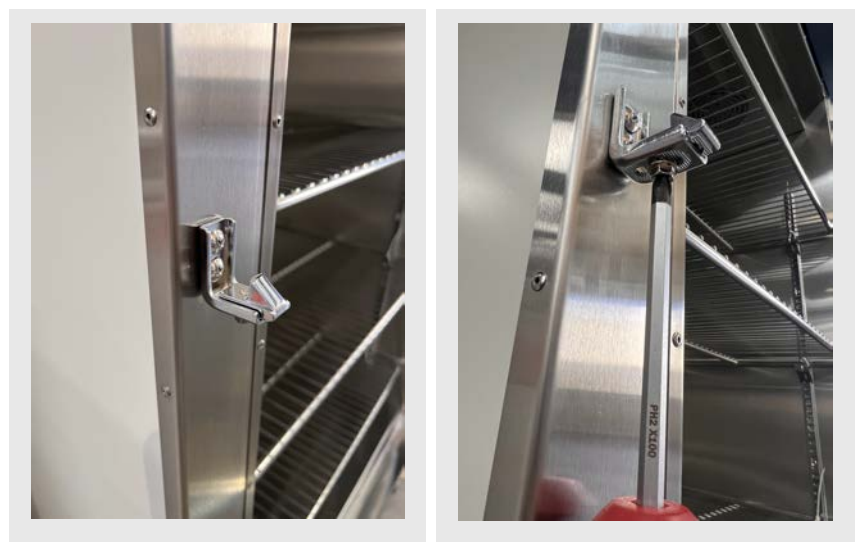

Fig 2.

Problem	Fix	Part Number
<p><b>Oven Temperature does not match the controller read out.</b></p>	<p><b>Sensor Issue</b> There could be a few reasons why the oven temperature is not matching the controller readout. One possibility is that the temperature sensor inside the oven is not properly calibrated or functioning correctly. If the offset is greater than 5 degrees, then your sensor may need replacing. Replace your Ovens sensor. To complete this, you will need to contact a technician.</p> <p><b>Offset Issue</b> Another issue could also be the offset of the controller being off and needing adjustment. Check the Offset in the controller. Select "iNS" - Input Shift and adjust accordingly. See Sensor Calibration for more in-depth information regarding Offset Calibration.</p>	<p>40716- PT100 Sensor</p> 
<p><b>The "ALM" light is illuminated on the controller and the PV is reading far higher than usual.</b></p>	<p>It is likely that the temperature offset has been inadvertently adjusted.</p> <p>Please follow the sensor calibration instructions to bring the "iNS" (Input Shift) value back to zero.</p>	
<p><b>There is no air flow in the oven</b></p>	<p><b>Fan Failure</b> Limited air flow within the Oven could be related to the failure of the internal fan.</p>	<p>50429 - D Series Motor</p> 
<p><b>The word "Stop" is showing on the controller</b></p>	<ol style="list-style-type: none"> <li>1. Press the 'PAGE' button and the "SCROLL' button simultaneously until 'oAPt' appears on the screen.</li> <li>2. Press 'SCROLL' button until you see the parameter 'PMSK' on the screen.</li> <li>3. Press the 'DOWN' button to turn off.</li> <li>4. Press the 'PAGE' button and the 'SCROLL' button simultaneously to take you back to the main menu.</li> <li>5. Press 'SCROLL' until you see 'R-S' on the screen.</li> <li>6. Press the 'DOWN' button to turn 'STOP' to 'RUN'</li> <li>7. Press the 'PAGE' and the 'SCROLL' button simultaneously until 'oAPt' appears on the screen</li> <li>8. Press 'SCROLL' until you see the parameter 'PMSK' on the screen</li> <li>9. Press the 'DOWN' button to turn on</li> <li>10. Press the 'PAGE' and the 'SCROLL' button simultaneously to take you back to the main menu.</li> </ol> <p><b>Please note if other parameters are changed by mistake further issues may occur.</b></p>	

## Troubleshooting

Problem	Fix	Part Number
<b>Lever latch door will not close (latch too tight) or does not close firmly (latch too loose).</b>	<b>Adjustable strike</b> If the latch feels overly tight or will not completely close the strike will likely need to be brought forward (away from the cabinet). Alternatively, if the latch feels loose when closed and it doesn't hold the door firmly closed the strike may need to be moved back (towards the cabinet). There is a Philips head screw in the bottom that once loosened will allow you to move the strike forwards or backwards. There is a grooved surface that enables the screw to remain in position once tightened. Thermoline suggests making only very small changes to the strike location (one groove at a time) while making adjustments.	
		

## Technical and Repair Support

When contacting Thermoline regarding information about the product, it is important to have the Serial Number and other related information with you. The serial number is on a silver sticker, usually located near the power IEC socket.

Contact Thermoline service on +61 2 9604 3911 or email at [service@thermoline.com.au](mailto:service@thermoline.com.au)



ABN 80 000 859 129  
SALES AND MANUFACTURING  
10-12 Ross Place, Wetherill Park NSW 2164 Australia  
Phone: +61 2 9604 3911 Email: [sales@thermoline.com.au](mailto:sales@thermoline.com.au)



Model:  
Serial No:  
Watts/Amps:  
Volts:



**Have the following information available when you contact the service department. Model number and serial number. This is generally found on the exterior of the cabinet in the form of a stick-on label. The company name, address, contact name, contact phone number. A brief description of the problem. All warranty claims must be reported to, and agreed to by a Thermoline representative prior to any work being carried out.**

## Standard 24 Month Warranty

### **Thermoline Scientific Equipment Pty Ltd ABN 80 000 859 129 ('Thermoline')**

Thermoline warrants to the original purchaser that this product will perform to its product specification for a period of 2 years from date of purchase, provided that the installation of the product has been carried out in accordance with the latest version of the manufacturer's instructions and further provided that the use of the product complies with that specified in the relevant specification. Thermoline is not responsible for any loss or damage arising from incorrect usage, usage outside the suitability of the product as stipulated in the manufacturer's instruction, damage caused by accident, fire, flood, act of God or failure to properly install, operate or maintain the goods in accordance with the printed instructions provided.

The following statement applies only to product sales that fall within the definition of a Consumer Sale set out in the Australian Consumer Law contained within the Competition and Consumer Act (Cth) 2012:

Our goods come with guarantees that cannot be excluded under the Australian Consumer Law. You are entitled to a replacement or refund for a major failure and for compensation for any other reasonably foreseeable loss or damage. You are also entitled to have the goods repaired or replaced if the goods fail to be of acceptable quality and the failure does not amount to a major failure. Notwithstanding the preceding clause and to the extent permissible by law, the liability of Thermoline is limited, in relation to the warranted product and at the option of Thermoline to:

Replacing the product or the supply of equivalent product;  
The repair of the product;  
The payment of the cost of replacing the product or of acquiring equivalent product; or  
The payment of the cost of having the product repaired.

To the extent permitted by law, all other warranties whether implied or otherwise, not set out in this Warranty are excluded and Thermoline is not liable in contract, tort (including, without limitation, negligence or breach of statutory duty) or otherwise to compensate the Purchaser for:

any increased costs or expenses;  
calibration/certification services;  
any loss of profit, revenue, business, contracts or anticipated savings;  
any loss or expense resulting from a claim by a third party.  
Any special, indirect or consequential loss or damage of any nature whatsoever caused by Thermoline's failure in complying with its obligations or the purchaser's failure due to accident damage, impact, misuse or negligence.

The benefits given to the purchaser in this Warranty are in addition to other rights and remedies under a law in relation to the products or services to which this warranty applies. This warranty applies only to products purchased and installed in Australia and does not cover any consumable items e.g. filters, light globes, ultrasonic nebulizers. The warranty does not extend to labour and freight costs where the warranted product is located outside Australia.

To make a warranty claim, contact Thermoline on 02 9604 3911 or [service@thermoline.com.au](mailto:service@thermoline.com.au).

# We are proudly Australian owned

We will continue to invest in Australian  
manufacturing.

